

FICHA TÉCNICA

NOBIS 2.0 400W

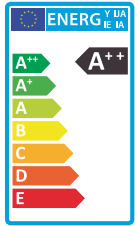

NOBIS
2.0

400W
48 000 LM
6500K

El Reflector Nobis consume hasta un 80% menos energia

- 80% AHORRO DE ENERGÍA
- 400 WATT
- AC 110-265V 50/60Hz
- 48 000 lm
- 6500K
- CRI ≥ 80
- 50,000 H
- 110° ÁNGULO
- Hg 0.0mg LIBRE DE MERCURIO



MEDIDAS

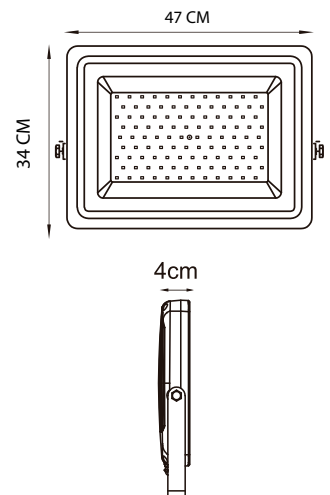

Potencia	Temperatura	IP	P.F	KV
400W	6500K	65	>0.90	>6

